

LCR-Reader-MP

Multi-Purpose Tweezer-Meter



Manual Version 1.15

SIBORG
SYSTEMS INC

1	Device Use	5
1.1	Main Features	5
2	What is included in the package	5
3	Symbols and Abbreviations	6
4	Principle of Operation	7
4.1	Formulas to Determine the Parameters:	8
5	Safety Measures and General Instructions	9
6	Device Controls	10
6.1	Turning on the device	10
6.2	Turning off the device	10
6.3	Extended Voltage Range Switch	10
6.4	Controlling Device Using Its Orientation	10
6.5	Charging the Battery	11
6.6	Main and System Menu	12
7	Modes of Operation	12
7.1	R-L-C-D Mode	12
7.1.1	Measurements	13
7.1.2	Quick Controls	14
7.1.3	Open/Short Calibration	15
7.1.4	Offset Calibration Board	15
7.2	R-L-C-D mode menu	16
7.2.1	Primary Parameter	16
7.2.2	Secondary Parameter	16

7.2.3	Test Frequency	16
7.2.4	Test Signal Level	17
7.2.5	Period	17
7.2.6	SER/PAR Mode	17
7.2.7	Sound	17
7.2.8	C-Voltage	17
7.2.9	Sample Hold	17
7.2.10	Large Cap	18
7.2.11	Large Cap (1 uF to 40 mF) Settings	19
7.2.12	Super Large Cap > 40 mF Measurement	19
7.3	RDC+LED mode	19
7.3.1	R test at 1.2 V and R test at 100mV	20
7.4	The Voltage mode	21
7.4.1	Controls	21
7.5	Transient voltage waveforms (oscilloscope mode)	22
7.6	Oscilloscope mode settings	22
7.6.1	Controls	22
7.7	Frequency Meter mode	22
7.7.1	Changing the mode	23
7.7.2	Frequency, Period control	23
7.8	Signal Generator Mode	23
7.8.1	Controls	24

8	Default Settings	24
8.1	Default Settings in R-L-C-D Menu	24
8.2	Default Settings in System Menu	25
9	Device Troubleshooting	25
9.1	If the device does not turn on	25
9.2	If there are no initial zero readings on the screen	25
9.3	Technical Support	26
10	Maintenance	26
10.1	Care of the surface	26
10.2	Repairs	26
11	Storage Conditions	27
12	Transportation	27
13	Warranty	27
14	Specifications	27
14.1	Overview	27
14.2	FCC Compliance	28
14.3	General Information	29
14.4	Details of the Measurement Modes	29
14.4.1	Test Signal Generator	29
14.4.2	Resistance	29
14.4.3	DC Resistance	31
14.4.4	Capacitance	31

14.4.5	DC Capacitance Measurement	33
14.4.6	Inductance	33
14.4.7	DC Voltage	34
14.4.8	AC Voltage	34
14.4.9	LF DDS Signal Generator	34
14.5	Supplement A	35
14.6	Supplement D	36

1 Device Use

1.1 Main Features

- Automatic component recognition L-C-R-Diode
- Basic Accuracy of 0.1%
- DC measurement of Resistance and Capacitance up to 1F
- Pass/No Pass Electrolyte Cap indication with Built-in Rejection table
- Automatic/manual frequency setting 100Hz, 10 Hz, 1kHz, 10 kHz, 100 kHz
- Automatic adjustment of test signal to 0.1 V peak-to-peak for in-circuit measurements
- Designated ESR measurements
- Easy Open/Short calibration for better accuracy
- Automatic detection of diode polarity and short circuits
- DC voltage measurements with automatic polarity detection
- Frequency meter
- Oscilloscope graphics for alternating voltage measurements
- Jog-dial control wheel
- Multiple Parameter Display: primary/secondary, etc.
- Screen orientation Automatic/Manually
- Sound indication
- Battery discharge warning, full charge indication
- Automatic power off when not in use
- Backlit LCD

2 What is included in the package

- LCR-Reader MP
- Case
- Offset Calibration Board
- Spare Ergonomic Bent Test Leads*
- Spare Battery*
- Kelvin Probe Connector*

* **Optional Accessories**

3 Symbols and Abbreviations

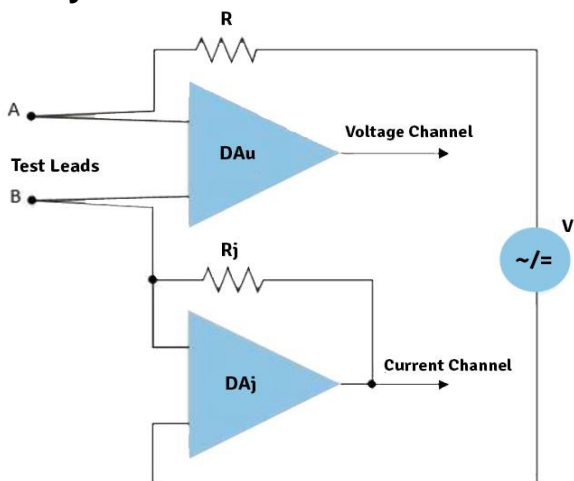

DUT – Device Under Test

ESR - Equivalent Series Resistance

Low ESR - Ultralow Equivalent Series Resistance

Rs - Series Resistance

Ls - Inductance in series connection

Cs - Capacitance in Series Connection

Xs - Reactance in Series connection

Rp - Resistance in Parallel connection

Lp - Inductance in Parallel Connection

Cp - Capacitance in Parallel Connection

Xp - Reactance in Parallel Connection

Q - Quality Factor

D - Loss Tangent

RMS - RMS value

TRMS – True RMS Value

LF - Low Frequency

Z - Impedance

$|Z|$ - Impedance Module

DDS - Direct Digital Frequency Synthesis

DC - DC Voltage

AC - Alternating Voltage

4 Principle of Operation

Fig. 1 shows the LCR meter block-diagram. Voltage from the voltage source through a limiting 1 kOhm resistor is applied to the DUT connected at points A and B. The amplitude and frequency of the Test Signal V are adjustable. It is *also possible to apply either positive or negative DC voltage to the DUT*. A voltage drop on the DUT is measured by DA_u . The voltage drop on resistor R_j measured by DA_j is proportional to the current flowing through the measured component. After digitizing the ADC signals the impedance is calculated according to the formula DUT impedance $Z = R_j * V_{au}/V_{aj}$.

Values of Impedance obtained during calibration with Open and Short probes are stored in the non-volatile memory of the device and are taken into account in the calculation of the impedance of the measured component thus eliminating the offsets due to the device internal parasitics.

The measured component can be represented in one of the following equivalent circuits:

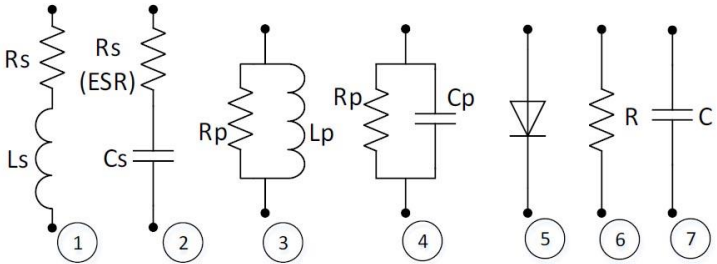

[1] and [2]: series circuits

[3] and [4]: parallel circuits

Impedance in series circuits $Z = R_s + iX_s$ and in parallel circuits $Z = 1/(1/R_p + 1/iX_p)$ where X_s (X_p) < 0 if the

reactance is capacitive and at $X_s (X_p) > 0$ the reactance is Inductive.

4.1 Formulas to Determine the Parameters:

Electrical capacitance $C = 1/(2\pi f |X_s|)$ where f is the test frequency.

Inductance $L = X_s/(2\pi f)$. $Q = |X_s|/R_s$. $D = 1/Q$. $|Z| = \sqrt{R_s^2 + X_s^2}$

The device automatically selects the optimum frequency and the equivalent circuit for measurements. Users can also manually select measurement mode and frequency of the test signal can be selected from 100 Hz to 100 kHz. Test voltage can be set to 0.65 V_{rms} and 0.1 V_{rms}.

By passing direct current through the measured component, the voltage and current can be measured. Using Ohm's law, the DC current Resistance (R) can be calculated [6].

By applying the DC voltage in forward and reverse direction, the diodes [5] are detected and the polarity of p-n junction is determined.

Charging and discharging the capacitor [7] by changing the voltage on the measured component for a fixed time interval to determine capacitance for capacitors above 40 mF.

The principle of the frequency counter is based on the counting pulses of the reference generator between the two ramps of the input signal for a certain period of time (by default about 1 second). At the same time, the quantity of periods of the input signal is counted too. Then the frequency f is calculated by the formula $f = M/N * f_r$ where f is the number of periods of the input signal, M is the number of periods of the input signal, N is the number of

pulses from the reference generator and f_r is the frequency of the reference generator

The principle of measuring the voltage is based on comparing the input signal with the reference voltage.

5 Safety Measures and General Instructions



For safe and reliable operation of the device, follow these rules:

1. Exercise additional caution when measuring the capacitance, inductance, resistance and diodes in a circuit with voltage applied
2. Never apply more than 20V DC or 14 Vrms to the probes with the device switch in position 2.
3. Never apply more than 1.5 V DC or 1.0 Vrms to the probes with the device switch in position 1.
4. Never measure Charged Capacitors
5. Do not make measurements while the device is charging
6. Charge the battery using a USB port of a computer or a DC charger 5 V +/- 5%. Do not use damaged cables or chargers. Charging in the presence of moisture may cause fire, electrical shock, injury or damage to the device or other property.
7. Do not stretch the handles for more than 20mm between the test leads.
8. This device is designed for indoor use.
9. To prevent injury from sharp ends of the test leads, transport the device in the case.
10. Do not touch non-insulated test lead surfaces during measurements. Keep fingers on the insulated surfaces of the handles.
11. Replacement of the battery must be carried out by a specialist. Batteries must be recycled or disposed of separately from regular household waste. Do not burn the battery.

6 Device Controls

6.1 Turning On the Device

Press the jog-wheel down and wait until the device beeps.

6.2 Turning Off the Device

1. Press the jog-wheel and hold it until the device shows “Shutdown”.
2. Hold with screen down for 3 beeps (may be enabled via menu).
3. The device turns off if it has been inactive for 120 seconds (default). The automatic time-off setting can be changed in the menu: *System /Power/Time Off*

6.3 Extended Voltage Range Switch

The switch is located at the left bottom of the housing. This switch extends the range of the voltage measurements. In the Voltage and Frequency modes, the side switch in Position 2 increases the input impedance of the device from 1 k Ω to 10 M Ω and extends the range of input voltages.

For RLCD and RD measurements, the switch should be set to Position 1.

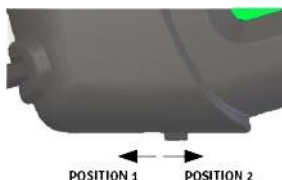

6.4 Controlling Device Using Its Orientation

1. If you rotate and hold the device perpendicular to the floor the screen will flip orientation to the hand being used. *

2. Turn the probes up to turn on/off the indicator light

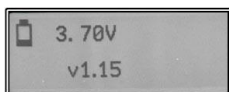

3. If you place the device on a flat surface with the screen facing up, after a few seconds the device will go into Economy mode. The display shows the battery voltage and the firmware number. *
4. If you place the device on a flat surface with the screen down, after 3 beeps the device will automatically turn off. *

*Function can be enabled/disabled through the device menu:
System/Power

6.5 Charging the Battery

The device is powered by a Li-Po battery with 3.7 V rated voltage. The battery icon on the display shows the remaining charge of the battery. This icon will blink when the device's power is below 3.6 V and will automatically turn off at 3.5 V. Information about the battery voltage can

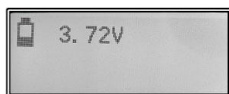

be displayed in the menu:
System/Power/Battery Voltage



Charge the battery by connecting it via a micro-USB cable to a USB DC voltage source of 5V +/- 5%. The device's indicator light will show when the device is charging and will turn off when the charging is complete.

6.6 Main and System Menu

The device will enter the main menu when the jog-wheel is pressed. The main menu is multi-levelled. Select the appropriate menu item by moving the jog-wheel in a clockwise or counter clockwise direction and pressing down to select.

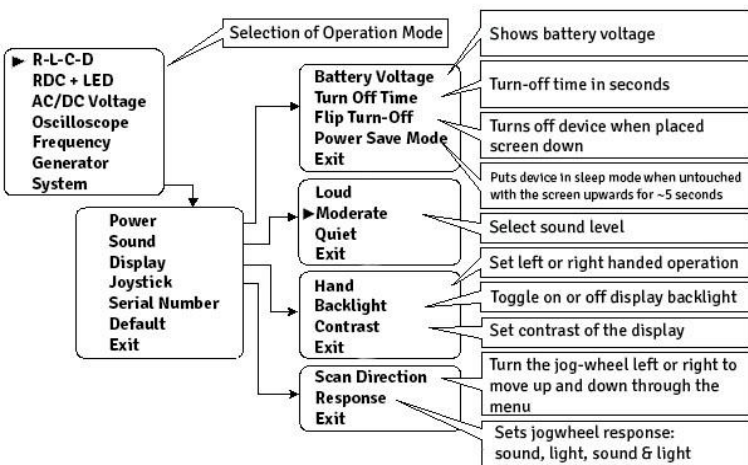

To select the menu item, highlight the corresponding menu item and press the jog-wheel.

To set the default operating mode (R-L-C-D, RDC+LED, Voltage, etc.), press and hold the jog-wheel for two beeps. This mode is then stored in the device's memory and will be activated when the device is powered on.

7 Modes of Operation

7.1 R-L-C-D Mode

This menu item is for measurement of Resistors, Capacitors, Inductances and Diodes. To select the mode, select R-L-C-D in the main menu. A typical screen looks as follows:

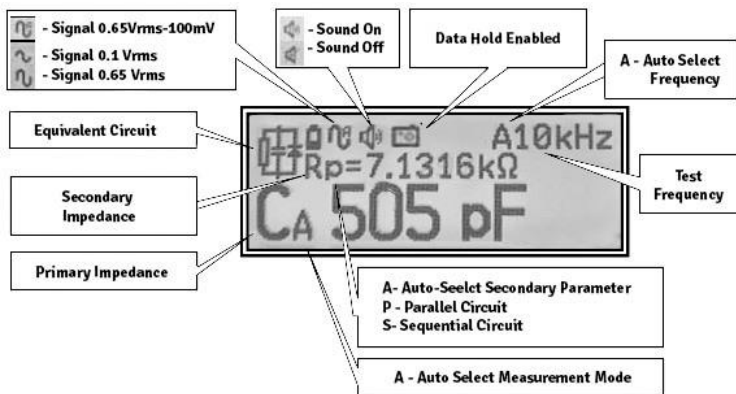

7.1.1 Measurements



Inductance



Capacitance

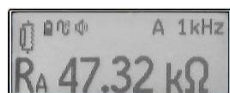

Resistance

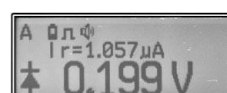

Diode

When the measured component is connected to the test leads, the screen displays information depending on the component and the selected settings in the R-L-C-D mode menu.

In automatic mode measurement of capacitance larger than 1 μ F is made at 120 Hz, while ESR is measured at 100 kHz. In this case the frequency of the test signal is not shown on the screen. For ESR based rejection of electrolytic capacitors two tables are used, one for standard aluminum electrolytic capacitors and the other for **Low ESR** capacitors.

In this case two additional figures are displayed. The first number is the quality of the capacitor. For standard aluminum capacitors a positive number indicate rejection,

and for **Low ESR** values above -10. The 2nd number is the selected operating voltage of the capacitor. It can be specified in the

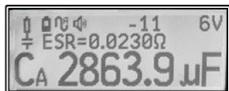

menu item **Large**

Cap/C-voltage.



Discharge Capacitors before testing!

7.1.2 Quick Controls

- Turn the jog-wheel clockwise* and hold for 1 beep to change the test parameters (more info below)
- Turn the jog-wheel counter clockwise and hold for 1 beep to change the test frequency. The frequency changes cyclically Auto-100Hz-120Hz-1kHz-10kHz-100kHz. If the frequency is selected from the menu in the range 20-75kHz, the frequency changes cyclically 20kHz-30kHz-40kHz-50kHz-60kHz-75kHz-100kHz
- Turn the jog-wheel clockwise and hold for 2 beeps to eliminate the offset. If the probes are shorted, parasitic resistance is obtained. If the probes are open, parasitic capacitance is obtained. Please use LCR-Reader Calibration Board to set a proper distance between the test leads (according to the component size) because the parasitic capacitance depends on the distance.
- Turn the jog-wheel counter-clockwise and hold for 1 beep to toggle the signal level between Auto and fixed 0.65Vrms
- If the probes are not connected to anything, press and hold up to 2 beeps to toggle the test frequency between Auto and 100 kHz. If a part is connected to the probes, then relative measurements are made showing the difference from the first measured component. Additional symbol in the top-middle of the screen is displayed.

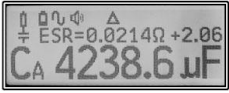

*When connected to the Capacitance is greater than 1 μF range for the operating voltage

7.1.3 Open/Short Calibration

Before the first use, the device must be calibrated with Open and Short probes for each test frequency. When the device is set to Auto-frequency the device automatically calibrates at 100Hz, 1 kHz, 10kHz, and 100kHz.

To eliminate the offset, turn the jog-wheel clockwise, hold for 2 beeps and release. When measuring small capacitances less than 100 pF, use LCR-Reader Offset Calibration Board included in the package. Insert the test leads at the distance of the size of the component and calibrate with open probes. Only then measure the capacitor.

Before measuring small inductances (less than 1 μH) and resistances (less than 10 Ohm) wipe off the tips of any dirt and oxides and calibrate with short probes.



7.1.4 Offset Calibration Board

The Offset Calibration Board provides a reliable method of determining the parasitic offset between the tips. The dummy PCB uses holes to represent various sizes of components.

To use the board, place the tips into the corresponding holes to the size of component under test; set open/short calibration by turning the jog-wheel clockwise and hold for 2 beeps and release. The result is the actual value of the component.



7.2 R-L-C-D mode menu

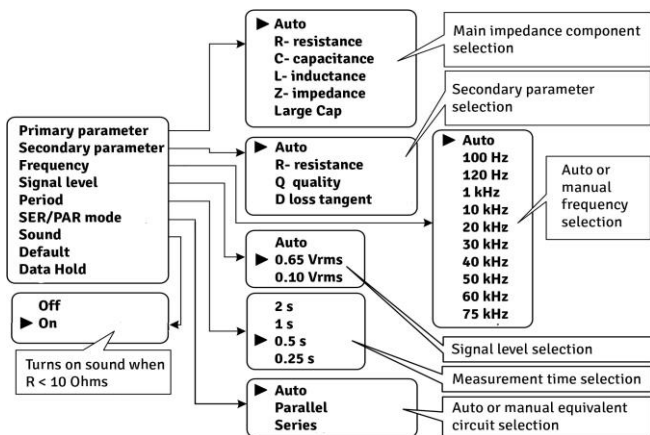

7.2.1 Primary Parameter

In Auto mode the type of measured component is determined automatically: R: Resistor, L: Inductance, C: Capacitor, D: Diode. Measurement mode can also be set manually to R, L, C, Z as the impedance.

7.2.2 Secondary Parameter

In Auto mode for inductors quality Q factor is displayed for $Q > 1$ and series Resistance R_s for $Q < 1$, and for capacitors, loss tangent for $C < 1 \mu\text{F}$ and ESR for $C > 1 \mu\text{F}$. Automatic secondary parameter selection does not work if the Test Signal is set to Automatic, R is used as the secondary parameter in this case.

7.2.3 Test Frequency

This menu item allows to select the frequency of the test signal. In Auto mode, the device automatically selects a frequency of 100Hz, 120 Hz, 1 kHz or 10 kHz, depending on the rating and type of the component. Users can also manually select the test frequency. A higher frequency is used for measuring small values of capacitances and inductances. Resistor measuring are always made at 1 kHz

unless **RDC+LED** Mode is selected. If 100 kHz frequency is required, press the jog-wheel and hold for 2 beeps.

7.2.4 Test Signal Level

For more stable readings, select 0.65Vrms or Auto signal level. Auto is best for measuring loose components and in-circuit measurements of R, C, L. When measuring on boards, if at high test signal level opens p-n junctions of semiconductors components causing an error in the measurements, then the signal level is automatically reduced to 0.1 V peak-to-peak and the value is re-measured. In this case, the screen shows the diode symbol and the direction of the p-n junction.

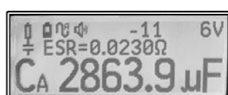

7.2.5 Period

Increased measurement time results in more stable readings, reduced time results in faster updates on the screen.

7.2.6 SER/PAR Mode

This is used to select the equivalent circuit depending on the characteristics of the element.

7.2.7 Sound

The device will beep when the resistance is less than 10 Ohm or a short circuit is found.

7.2.8 C-Voltage

This setting has to be selected in the menu when evaluating electrolytic capacitors for rejection by ESR. The voltage is written on the capacitor's housing.

7.2.9 Sample Hold

When selected, the device will hold measurement data on the screen. A beep will sound when the measurement is

made and the values are held on the screen after the component has been disconnected from the device. The device will only reset when a new component is measured or the test probes are shorted.

In order to set the default measurement mode when the device is turned on, select the mode, press the jog-wheel and hold for 2 beeps. This measurement setting will be stored in the device's non-volatile memory for all other measurements until selecting other parameters or Default in the menu.

7.2.10 Large Cap

In this mode, capacitance and ESR of capacitors from 1 μF to 40 mF are measured. The capacitance is measured at a frequency of 50Hz, and the capacitor's ESR is measured at the frequency of 100 kHz.

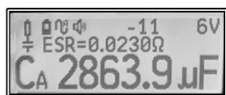

Discharge Capacitors before testing!

If open p-n junctions of semiconductor components cause an error in the measurements, then the screen shows the diode symbol and the direction of the p-n junction is shown instead of the primary parameter type.

If the resistance of the component is less than 10 ohms, there will be short beeps. Before the first application in this sub-mode it is necessary to calibrate the device with both open and shorted probes.

For the rejection of electrolytes based on ESR, two tables are stored in the memory of the device, one for standard aluminum capacitors and the other for **Low ESR** capacitors. Two additional numbers are displayed on the screen in this case: the first number is the quality of the capacitor. For standard aluminum capacitors, positive values indicate rejection, and for **Low ESR** rejected values are above -10. The second number is selected operating voltage of the

capacitor in menu under C voltage: 6.3, 10, 16, 2, 3, 50-63, 100, and 160+ Volts. This menu opens by clockwise turn of the jog-wheel.

7.2.11 Large Cap (1 μ F to 40 mF) Settings

- Clockwise for 1 beep to open the mode menu.
- Clockwise for 2 beeps to make calibration eliminating the offset. Only short calibration is required.
- Counter clockwise for 2 beeps to toggle the test signal level between 0.65 Vrms and 0.1 V peak-to-peak.

7.2.12 Super Large Cap > 40 mF Measurement

- When in the Large Cap mode, counter clockwise for 1 beep to switch to DC capacitance measurement mode for Capacitors larger than 40 mF up to 680 mF. To speed up the settling of the readings, short the capacitor leads for 2-3 seconds before the measurements. Counter clockwise for 1 beep again to return to the normal Large Cap mode.

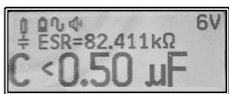

Discharge Capacitors before testing!

7.3 RDC+LED mode

This mode is designed to measure DC resistance, parameters of Diodes/LEDs, and leakage currents. Besides, it allows to measure a shunt resistor on a board that can be used for evaluating the current via that shunt in a live circuit.

- Clockwise for 1 beep to open the mode menu. Select sub-modes: Auto, Diode, R test at 1.2 V, R test at 100 mV.

- Clockwise for 2 beeps to calibrate with open and short probes to eliminate the offset.

In the Auto mode resistances and diodes are automatically detected. The bottom line displays the resistance of the connected element, at the top the current I_r flowing through it. For diodes, the polarity of the diode, the voltage drop in the open state and the reverse current I_r are displayed.

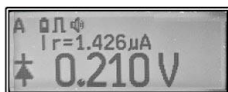
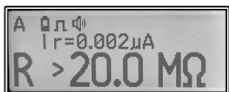

Diode mode is used for diode parameter extraction using DC bias. It is recommended for in-circuit characterization of p-n junctions. The screen displays the voltage drop in the open state when the forward bias is applied. If the reverse bias is applied, OL is displayed instead. Turn the jog-wheel counter-clockwise and hold for 1 beep to change the polarity of the probes.

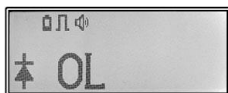
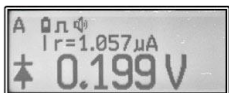

7.3.1 *R test at 1.2 V and R test at 100mV*

These modes are used to measure DC resistance, recommended for in-circuit detection of resistors. It also allows to measure a shunt resistor on the board that could be used for current measurements.

- Press and hold for 1 beep to save the resistance value (shunt) in the device memory for the current measurements. Read below about the current measurement in the **Voltage mode** section.

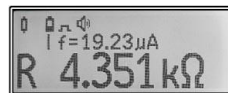
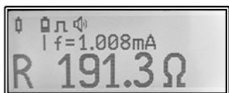

7.4 The Voltage mode

This mode is to measure DC and AC voltage. The device automatically detects the polarity of the DC voltage. The upper line of the display shows the values of the RMS voltage. The second line shows the peak-to-peak voltage range.

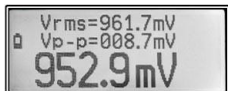

7.4.1 Controls

- Clockwise for 1 beep turns on (off) the current measurement mode.

In this mode, the voltage value measured on the external resistors (shunts) is converted into a current and displayed on the screen. In the upper line of the screen the resistance is displayed, taking into account the input resistance of the device, and the lower value of the current. To enter the resistance of the shunt into the instrument memory, go to the RDC+LED mode. With the circuit de-energized, connect the shunt and press the switch, hold for 2 beeps.

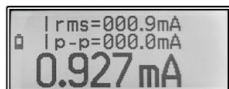
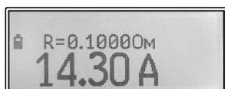

- Anti-clockwise for 1 beep to turn on and off the capture mode of the maximum and minimum voltage values.

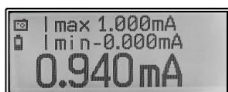

- Clockwise for 2 beeps to calibrate with short probes to eliminate the offset. The switch must be in position 1 in order to do the calibration (see Section 6.3 Extended Voltage Range Switch).

7.5 **Transient voltage waveforms** (*oscilloscope mode*)

In this mode, you can view the voltage waveform. On the right side of the screen, the horizontal scale (T / pixel), vertical scale (V / div), signal frequency and signal sweep are displayed.



7.6 **Oscilloscope mode settings**

Usually automatic parameter settings are acceptable. The two parameters can be adjusted manually are, the time scale (T/pix) and the voltage scale (V/div).

7.6.1 **Controls**

- Clockwise for 1 beep to increase parameter.
- Counter-clockwise for 1 beep to decrease parameter.
- Counter -clockwise for 2 beeps to select the parameter to change: T/pix or V/div.
- Clockwise for 2 beeps to automatic selection of T/pix (V/div).
- Press and hold up to 2 beeps to enter the waiting oscilloscope mode. In the window, set the parameters T/pix and V/div as indicated above. Press and hold up to 2 beeps again to activate the mode. The word "Wait" is displayed on the screen. When the signal is applied to the probes, 675 sample points are recorded. Turn the jog-wheel clockwise or counter clockwise to view the signal on the screen.

7.7 **Frequency Meter mode**

In this mode, it is possible to measure frequency, pulse duration, duty cycle, period and count the number of pulses.

7.7.1 Changing the mode

Clockwise for 1 beep to open menu to select the desired mode. When the mode is selected, hold for 2 beeps to make the mode default.

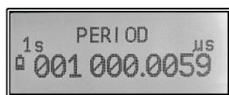
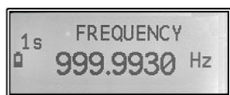

7.7.2 Frequency, Period control

- Counter-clockwise for 1 beep to change the measurement time cyclically 0.25s-0.5s-1s-2s.

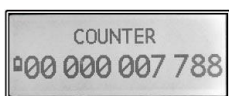

- Counter-clockwise for 1 beep to reset the counter

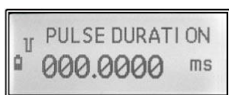

- Counter-clockwise for 1 beep to measure of a positive or negative pulse.

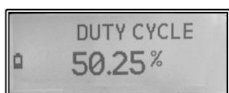

7.8 Signal Generator Mode

Sine, triangle, and rectangle signals are generated. The signal is applied to the device probes. It is possible to adjust the span (peak-to-peak) of a signal from 0.1 to 2.8 V, a constant bias of ± 0.6 V *, and a duty cycle of 5 - 95% in 5% increments. Parameters are stored when exiting the mode. On the right of the screen from top to bottom: sweep, offset, duty cycle and the waveform icon. The frequency in Hz is displayed in the center of the screen.

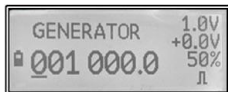
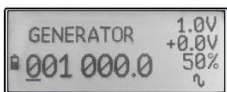

The self-shutdown time is 4 times longer than the default in other modes. An external decoupling capacitor is required to supply a signal to a circuit under voltage. It should be connected to a probe located closer to the side switch. The other probe is a common one. In this mode, the device does not turn-off by "flipping" and the function of automatic change of display orientation (left/right hand) is disabled. It is recommended to use LCR-Reader Kelvin Probe Connector to simplify the device operation in this mode.

7.8.1 Controls

- Clockwise for 1 beep to select the item to change.
- Counter-clockwise for 1 beep to increase the selected parameter.
- Clockwise for 2 beeps to go to the initial position.
- Hold the jog-wheel down for 2 beeps to change the waveform type.
- The sum of the displacement and 1/2 of the span must be less than or equal to 1.4 V.

8 Default Settings

8.1 *Default Settings in R-L-C-D Menu*

Error! No index entries found. The following settings are stored in the device EEPROM when Default in the R-L-C-D Menu is selected:

- Primary Parameter Auto
- Secondary Parameter Auto
- Frequency Auto
- Signal Level 0.65 Vrms
- Measurement Period 0.5 s

- Equivalent Circuit Auto
- Sound On
- Data Hold Off

8.2 *Default Settings in System Menu*

The following settings are stored in the device EEPROM when Default in the System Menu is selected:

- Primary Parameter Auto
- Secondary Parameter Auto
- Frequency Auto
- Signal Level 0.65 Vrms
- Measurement Period 0.5 s
- Equivalent Circuit Auto
- Sound On
- Data Hold Off
- Shutdown Time 120 s
- Wakeup Mode R-L-C-D
- RDC+LED Mode Auto
- Frequency Mode Frequency
- Frequency Measurement Time 1 s
- System Sound Medium
- All offsets are reset to zero

9 Device Troubleshooting

9.1 *If the device does not turn on*

- a. Push the joystick and hold it for 1 beep, then release it.
- b. Charge the battery.
- c. Contact the manufacturer for repair.

9.2 *If there are no initial zero readings on the screen*

- a. From the system menu, select Default.

- b. Clean the contacts and calibrate with both closed and open probes.
- c. Review this manual to find possible errors in operating the device.

9.3 *Technical Support*

Customers can contact customer support by phone +1-519-888-9906 or by e-mail info@lcr-reader.com.

When contacting technical support, please provide the following information:

- Model number
- Serial number of the device
- Software version number

10 Maintenance

10.1 *Care of the surface*

- a. Do not expose housing to water, it is not waterproof.
- b. Do not expose the display for a long period of time to direct sunlight.
- c. Use a soft cloth dampened with water to clean the outside surface and cleaning the LCD display device.
- d. Do not use liquid solvents or detergents.

10.2 *Repairs*

If there is an unexpected measurement result, check the quality of the contact between the tips of the device probes and the element being examined. Make sure you make the measurements correctly. Carry out the instrument diagnostics. Not allowed independent dismantling of the case, replacement of individual elements and circuits. For repair, please contact the manufacturer.

11 Storage Conditions

- Temperature and humidity during storage: -10°C to 50°C with relative humidity $<80\%$.
- There should be no dust, acid and alkali vapours in the storage room.
- Recharge the built-in battery once every 6 months.

12 Transportation

All modes of transportation at ambient temperatures from -40°C to $+50^{\circ}\text{C}$

The device must be protected against precipitation and dust.

13 Warranty

The manufacturer (dealer) guarantees the conformity of the device parameters to the data, described in the Technical specifications subject to the consumer rules of operation, maintenance and storage, specified in this manual. Warranty period - 12 months. The warranty period for the battery is 6 months. This warranty does not cover normal wear and tear on the surface of the case, the display, the probes. This warranty does not apply to physical damage to the housing, display, probes, switches, electrical damage to the product due to high voltage.

14 Specifications

The limits of the absolute error are given as \pm (% of the measured value + the number of LSB digits) at $23^{\circ}\text{C} \pm 5^{\circ}\text{C}$, humidity less than 80% and 15 minutes of operation.

14.1 Overview

R-L-C	
Measurement Parameters	C+R, L+R, R, C+D, C+ESR, L+Q, Z+ θ
Measuring Time	0.25 s, 0.5 s, 1.0 s, 2.0 s

Generator Test Signal	Frequency	50 Hz, 100 Hz, 120 Hz, 1 kHz, 10 kHz, 20 kHz, 30 kHz, 40 kHz, 50 kHz, 75 kHz, 100 kHz
	Voltage	0.65 Vrms, 0.1 V peak-to-peak
Resistance (R)	Range	0...20 MOhm
	Maximum Resolution	0.001 Ohm
Capacitance (C)	In RLCD Mode Range	0... 680 000 μ F
	Maximum Resolution	0.001 pF
Inductance (L)	Range	0...100 H
	Maximum Resolution	0.001 μ F
Quality Factor (Q)		0.001...1000
Loss Tangent (D)		0.001...1000
Loss Angle (θ)		-90...90°
Diode		
Maximum Voltage Test		2.8 V
Voltage Measurement Error		$\pm(3\%+5)$ V
Maximum Test Current		2.8 mA
Current Measurement Error		$\pm(3\%+5)$ A
Voltage		
Range		- 15 V...15 V (-1.2 V...1.2 V*)
Maximum Resolution (DC)		1 mV (1 μ V*)
Input		DC+AC
Input Impedance		1 kOhm or 10 MOhms *
Frequency		
Frequency		25 Hz – 100 kHz
Measuring Time		0.25 s, 0.5 s, 1s, 2s
Maximum Resolution		0.0001 Hz
Sensitivity		0.25 V (10 mV*)
Error		$\pm(0.005\%+5)$ Hz
Input Impedance		1 kOhm or 10 MOhms**
Signal Generator		
Waveform		Sine, Square, Triangle
Maximum Frequency		100 kHz

* with the input impedance of the device 1 kOhm

** depending on the position of the extended voltage measurement range switch

14.2 FCC Compliance

Complies with ICES-003 Issue 6 and FCC Part 15.109.

14.3 General Information

Type of Indicator		Monochrome graphic LCD display with backlight
Power	Battery	Lithium-Polymer (Li-Poli) 3.7V 250 mAh
	Typical Recharge Time	2.5 hours
	Continuous Operating Time	Over 8 hours (non-illuminated display)
	Auto-off	10 - 990 seconds (default 120s)
Use Conditions		10 - 40°C and relative humidity up to 80%
Dimensions	Device	180x30x16mm
	Case	205x80x25mm
Unit Weight		45 g
Weight of the Device and Case		103 g

14.4 Details of the Measurement Modes

14.4.1 Test Signal Generator

Test Frequency	50Hz, 100Hz, 120Hz, 1kHz, 10kHz, 20kHz, 30kHz, 40kHz, 50kHz, 60kHz, 75kHz	100kHz	Constant Pressure
Frequency Setting Accuracy	0.01%	1.5%	-
Test Signal Level	0.65±0.05 Vrms*, 0.1±0.01 Vrms, 0.1±0.01 V**		±(n±0.1) V, where n=1.2,1.5,2, 7
Output Impedance	1000 Ohm		

* At the test frequency 30 kHz ± 0.53±0,04 Vrms.

**No manual selection of the signal level, measurement accuracy 10% + 5.

14.4.2 Resistance

Range	Resolution	Level	Test Frequency	Equivalent
-------	------------	-------	----------------	------------

			100 Hz, 120 Hz	1 kHz	10kHz	20kHz- 100kHz	Circuit
10Ω	0.001Ω	0.1 Vrms	-	-	-	-	Series
		0.65 Vrms	0.5 %+20	0.2 %+20	0.5 %+20	1%+20	
100Ω	0.01Ω	0.1 Vrms	0.5 %+3	0.4 %+3	0.5 %+3	3%+3	Series
		0.65 Vrms	0.2 %+3	0.1 %+3	0.2 %+3	1%+3	
1kΩ	0.1Ω	0.1 Vrms	0.5 %+5	0.2 %+5	0.5 %+5	2%+5	Series
		0.65 Vrms	0.2 %+2	0.1 %+2	0.2 %+2	0.5%+2	
10kΩ	0.001kΩ	0.1 Vrms	0.5 %+5	0.2 %+5	0.5 %+5	1%+5	Series, Parallel
		0.65 Vrms	0.2 %+2	0.1 %+2	0.2 %+2	0.5%+2	
100kΩ	0.01kΩ	0.1 Vrms	0.5 %+5	0.5 %+5	0.5 %+5	1%+5	Parallel
		0.65 Vrms	0.2 %+2	0.1 %+2	0.2 %+2	0.5%+2	
1MΩ	0.1kΩ	0.1Vr ms	1.0 %+5	0.5 %+5	1.0 %+5	3%+5	Parallel
		0.65 Vrms	0.5 %+3	0.2 %+3	0.5 %+3	5%+3	
10MΩ	0.001MΩ	0.1Vr ms	1.0 %+5	0.5 %+5	1.0 %+5	-	Parallel
		0.65 Vrms	0.5 %+5	0.2 %+5	0.5 %+5	-	
20MΩ	0.01MΩ	0.1Vr ms	-	-	-	-	Parallel
		0.65	1.0 %+5	0.5	-	-	

	Vrms		%+5		
--	------	--	-----	--	--

- Calibrate with short and open test leads before measurement
- If D exceeds 0.1 then multiply the result by $\sqrt{1 + D^2}$
- Measurement time 1 sec

14.4.3 DC Resistance

Range	Resolution	Accuracy
10Ω	0.001Ω	1%+20
100Ω	0.01Ω	0.5%+3
1kΩ	0.1Ω	0.3%+2
10kΩ	0.001kΩ	0.3%+2
100kΩ	0.01kΩ	0.3%+2
1MΩ	0.1kΩ	0.5%+3
10MΩ	0.001MΩ	3%+5
20MΩ	0.01MΩ	5%+5

- Calibrate with short and open test leads before measurement
- Test signal 1.2 V

14.4.4 Capacitance

Range	Resolution	Level	Test Frequency					
			50Hz	100Hz, 120Hz	1kHz	10kHz	20kHz- 75kHz	100kHz
10 pF	0.00 1pF	0.1Vrms	-	-	-	-	-	-
		0.65 Vrms	-	-	-	-	-	2.0% +50*
100 pF	0.01 pF	0.1Vrms	-	-	-	-	-	-
		0.65 Vrms	-	-	-	0.5 %+5*	1.0 %+5*	0.2 %+5*
1000 pF	0.1 pF	0.1Vrms	-	-	-	3.0 %+5*	1.0 %+5*	1.0 %+5*
		0.65 Vrms	-	-	1.0 %+1 0*	0.2 %+2*	0.3 %+2*	0.2 %+2 *
10 nF	0.001 nF	0.1Vrms	-	-	1.0 %+5	1.0 %+5	1.0 %+5	0.5 %+5
		0.65	-	5%+20	0.1	0.3%	0.2	0.2

		Vrms			%+2	+2	%+2	%+2
100 nF	0.01 nF	0.1Vrms	-	5%+5	0.5 %+5	1.0 %+5	1.0 %+5	1.0 %+5
		0.65 Vrms	-	0.5%+ 2	0.1 %+2	0.2 %+2	0.3 %+2	0.2 %+2
1000 nF	0.1 nF	0.1Vrms	-	2%+5	0.5 %+5	1.0 %+5	2.0 %+5	2.0 %+5
		0.65 Vrms	-	0.5%+ 2	0.1 %+2	0.2 %+2	0.3 %+3	0.2 %+3
10 µF	0.00 1 µF	0.1Vrms	-	2%+5	1.0 %+5	3%+5	-	-
		0.65 Vrms	3%+3	0.5%+ 2	0.2 %+2	0.3 %+2	2.0 %+5	2.0 %+5
100 µF	0.01 µF	0.1Vrms	5%+5	2%+5	1.0 %+5	-	-	-
		0.65 Vrms	2%+2	0.5%+ 2	0.3 %+2	1 %+5	-	-
1000 µF	0.1 µF	0.1Vrms	2.0 %+5	1.0 %+5	-	-	-	-
		0.65 Vrms	0.5 %+2	0.5 %	1.0 %+5	-	-	-
5000 µF	1 µF	0.1Vrms	5.0 %+5	-	-	-	-	-
		0.65 Vrms	1.0 %+5	1.0 %+5	-	-	-	-
40 mF	0.01 mF	0.1Vrms	-	-	-	-	-	-
		0.65 Vrms	5.0 %+5	-	-	-	-	-

* Calibrate with open probes using LCR-Reader Offset

* Calibration Board with a proper component size

- Calibrate with short and open test leads before measurement
- If D exceeds 0.1 multiply the result by $\sqrt{1 + D^2}$
- Capacitance measurements are performed at the automatic selection of the equivalent circuit, test signal 0.65 Vrms or 0.1 Vrms.
- Discharge capacitors before measurement.
- Measurement time 1 sec.

14.4.5 DC Capacitance Measurement

Range	Resolution	Error
40-100mF	0.01mF	5%+5
680mF	0.1mF	5%+5

- Discharge capacitors before measurement

14.4.6 Inductance

Range	Resolution	Level	Test Frequency				
			100Hz, 120Hz	1kHz	10kHz	20kHz- 75kHz	100kHz
10 μ H	0.001 μ H	0.1Vrms	-	-	-	-	-
		0.65 Vrms	-	-	-	-	2.0 %+25
100 μ H	0.01 μ H	0.1Vrms	-	-	-	-	2.0 %+10
		0.65 Vrms	-	-	1.0 %+5	1.0 %+5	1.0 %+3
1000 μ H	0.1 μ H	0.1Vrms	-	-	1.0 %+5	1.0 %+5	1.0 %+5
		0.65 Vrms	-	0.5 %+3	0.2 %+2	0.2 %+2	0.2 %+2
10 mH	0.001 μ H	0.1Vrms	-	1.0 %+5	1.0 %+5	1.0 %+5	1.0 %+5
		0.65 Vrms	0.5 %+3	0.3 %+2	0.2 %+2	0.2 %+2	0.2 %+2
100 mH	0.01 mH	0.1Vrms	0.5 %+5	1.0 %+5	1.0 %+5	1.0 %+5	1.0 %+5
		0.65 Vrms	0.3 %+2	0.2 %+2	0.2 %+2	0.2 %+2	0.2 %+2
1000 mH	0.1 mH	0.1Vrms	1.0 %+5	1.0 %+5	1.0 %+5	-	-
		0.65 Vrms	0.2 %+2	0.2 %+2	0.2 %+2	2.0 %+5	2.0 %+5
10 H	1 mH	0.1Vrms	1.0 %+5	1.0 %+5	-	-	-
		0.65 Vrms	0.3 %+2	0.3 %+2	1.0 %+3	-	-
100 H	0.01 H	0.1Vrms	2.0 %+5	-	-	-	-
		0.65 Vrms	0.5 %+3	1.0 %+3	-	-	-

- Calibrate with short and open test leads before measurement
- If D exceeds 0.1 multiply the result by $\sqrt{1 + D^2}$
- Inductance measurements are performed at the automatic selection of the equivalent circuit, test signal 0.65 Vrms or 0.1 Vrms.
- Measurement time 1 sec.

14.4.7 DC Voltage

Range	Resolution	Accuracy	The Input Impedance of the Device
10 mV	0.001 mV	3%+5	1 kOhm
100 mV	0.01 mV	1%+2	1 kOhm
1000 mV	0.1 mV	0.5%+3	1 kOhm
1.2 V	0.001 V	0.5%+3	1 kOhm
10 V	0.001 V	0.5%+3	10 MOhm
15 V	0.01 V	0.5%+3	10 MOhm

- Presence of the AC voltage will result in lower accuracy

14.4.8 AC Voltage

Range	Resolution	Error	Input Impedance of the Instrument	Frequency
75 -1000 mV	0.1 mV	5%+3	1 kOhm	30 – 50000 Hz
1.0 -1.2 V	0.001 V	5%+3	1 kOhm	30 – 50000 Hz
0.1 -15 V	0.01 V	5%+3	10 mOhm	30 – 3000 Hz

- Presence of the DC offset $\pm 5\text{mV}$ will result in lower accuracy

14.4.9 Low Frequency DDS Signal Generator

The Shape and Frequency of the Output Signals	Sine	20 Hz-100 kHz
	Rectangle	20 Hz-5 kHz
	Triangle	20 Hz-20 kHz
Step Frequency Adjustment	0.1 Hz	
Bit DAC	12 bits	
The Maximum Number of Samples Per Channel	512	

Maximum Output Level (peak-peak)	2.8 V
Step Changes the Output Voltage	0.1 V
Setting Error Amplitude	±(5% of the set level plus 0.02 V)
Change limits Vertical Shift Signal	±0.6 V
The rise time of the rectangular signal	Typical 5 μs
Maximum sampling frequency	1.5 MHz
Accuracy	Better than 0.02%
Output Impedance	1 kOhm

*We reserve the right to adjust specifications without prior notice

14.5 Supplement A

ESR rejection table for standard aluminum capacitors stored in the device memory

Capacitance μF	Volts							
	6.3	10	16	25	35	50-63	100	>160
1.0	-	-	-	-	-	142	118	74
2.2	-	-	-	-	-	64	54	34
3.3	-	-	-	-	-	43	36	22
4.7	-	-	-	-	-	30	25	16
6.8	-	-	-	-	-	21	17	11
10	-	-	-	-	-	14	12	7.4
22	-	-	-	-	-	6.5	5.4	3.4
33	-	-	-	-	5	4.3	3.6	2.2
47	-	-	-	4	3.5	3.0	2.5	1.7
68	-	-	3.5	2.7	2.4	2.1	1.7	1.1
100	-	2.9	2.4	1.9	1.7	1.4	1.2	0.75
150	-	1.9	1.6	1.3	1.1	0.95	0.79	0.49
220	1.5	1.3	1.1	0.86	0.75	0.65	0.54	0.34
270	1.2	1.1	0.88	0.7	0.61	0.53	0.44	0.27
330	1.0	0.86	0.72	0.57	0.50	0.43	0.36	0.22
470	0.71	0.61	0.50	0.40	0.35	0.30	0.25	0.16

560	0.59	0.51	0.42	0.34	0.30	0.25	0.21	0.13
680	0.49	0.42	0.35	0.28	0.24	0.21	0.17	-
1000	0.33	0.29	0.24	0.19	0.17	0.14	0.12	-
1500	0.22	0.19	0.16	0.13	0.11	0.09	-	-
2200	0.16	0.14	0.12	0.10	0.09	0.08	-	-
3300	0.11	0.10	0.09	0.07	0.08	0.06	-	-
4700	0.09	0.08	0.07	0.06	0.06	0.05	-	-
6800	-	0.06	0.05	0.05	0.05	-	-	-
8200	-	0.06	0.05	0.04	-	-	-	-
10000	-	0.05	0.04	0.04	-	-	-	-

14.6 Supplement D

ESR rejection table for Low ESR capacitors stored in the device memory

Capacity in μF	Volts						
	6.3	10	16	25	35	50	100
1.0	-	-	-	-	-	4.0	3.7
2.2	-	-	-	-	-	2.4	2.3
3.3	-	-	-	-	-	2.0	1.9
4.7	-	-	-	-	-	1.7	1.6
10	-	-	-	-	-	1.33	1.25
22	-	-	-	-	-	0.73	0.68
33	-	-	-	0.67	0.64	0.56	0.32
47	-	-	0.57	0.54	0.51	0.45	0.25
100	0.60	0.48	0.37	0.35	0.33	0.29	0.16
220	0.31	0.25	0.19	0.18	0.13	0.11	0.085
330	0.25	0.17	0.15	0.11	0.10	0.091	0.068
470	0.18	0.14	0.093	0.088	0.084	0.074	-
1000	0.066	0.063	0.060	0.057	0.054	0.048	-
2200	0.038	0.036	0.034	0.032	0.031	0.027	-
3300	0.032	0.030	0.029	0.027	0.026	-	-
4700	0.027	0.025	0.024	0.023	-	-	-
6800	0.024	0.023	0.022	-	-	-	-
10000	0.021	0.020	-	-	-	-	-
15000	0.020	-	-	-	-	-	-